

SSP

Installers

Pocket Guide

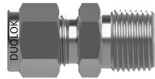

Duolok®



At SSP, we are proud to be an American manufacturing success story.

100% of our products are made in America. All of our manufacturing is performed in our 165,000 sq. ft. facility located near Cleveland, Ohio. Our facility is the largest vertically integrated, single-site operation in the industry. In addition to manufacturing and assembly, we have closed die forging, tool & die design, product engineering and testing operations under the same roof with customer service and management.

Made in America is good business. Not only do we make everything in America, we use American suppliers too. Buying American allows us to have better quality control and a more reliable supply chain. We can work more closely within our walls and with our suppliers to improve quality, reduce costs, and shorten lead times, which means faster service and better products for you.









Support where it counts. SSP products and services are supported by more than 4000 people and 350 distributor locations around the globe. For a distributor near you, contact SSP Customer Service or visit www.mySSP.com/distributors.

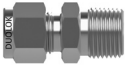
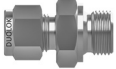
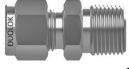

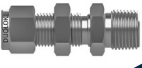
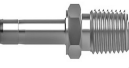
Table of Contents

Table of Contents





Visual Index	2
Installation Instructions	
Initial Installation	7
Reassembly Instructions.....	9
Pre-Setting Instructions	10
SSP Gap Gage Instructions	12
Technical Data.....	13
SSP Duolok® Fittings	
Tube to Male Pipe	16
Tube to Female Pipe.....	30
Tube to Tube Union.....	37
Tube to Welded Systems	45
Tube Stub Connectors / Adapters.....	47
Duolok® 37° Flare (AN).....	54
Tube to O-Ring Seal.....	55
Tube to SAE / MS	56
Cap and Plug	59
Components.....	61
SSP Tubing.....	66
Safety Information	67
Limited Lifetime Warranty	67





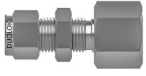
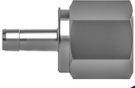

Visual Index

Tube to Male Pipe		
<p>Male Connector</p>  <p>MC 16-17</p>	<p>Male Connector ISO Parallel</p>  <p>MCRS 18-19</p>	<p>Male Connector ISO Tapered</p>  <p>MCRT 20-21</p>
<p>Male Connector Bored Through</p>  <p>MCBT 22</p>	<p>Bulkhead Male Connector</p>  <p>BMC 23</p>	<p>Male Adapter</p>  <p>MA 50</p>
<p>Male Elbow</p>  <p>ME 24-25</p>	<p>Male Elbow – ISO Parallel</p>  <p>MERS 26</p>	<p>Male Elbow – ISO Tapered</p>  <p>MERT 26-27</p>
<p>45° Male Elbow</p>  <p>M45E 23</p>	<p>Male Branch Tee</p>  <p>MBT 28</p>	<p>Male Run Tee</p>  <p>MRT 29</p>

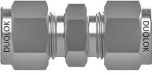
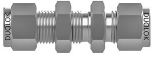
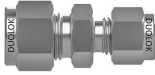
Tube to Female Pipe		
<p>Female Connector</p>  <p>FC 30-31</p>	<p>Female Connector ISO Parallel</p>  <p>FCRG 32</p>	<p>Female Connector ISO Tapered</p>  <p>FCRT 33</p>

Continued on the next page

Tube to Female Pipe		
<p>Bulkhead Female Connector</p>  <p>BFC 32</p>	<p>Female Adapter</p>  <p>FA 51</p>	<p>Female Elbow</p>  <p>FE 34</p>
<p>Female Branch Tee</p>  <p>FBT 35</p>	<p>Female Run Tee</p>  <p>FRT 36</p>	

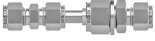
Tube to Tube Union		
<p>Union</p>  <p>U 37</p>	<p>Bulkhead Union</p>  <p>BU/BRU 38</p>	<p>Reducing Union</p>  <p>RU 39</p>
<p>Union Elbow</p>  <p>UE 40</p>	<p>Union Tee</p>  <p>UT 42</p>	<p>Reducing Union Tee</p>  <p>RUT 43</p>
<p>Union Cross</p>  <p>UCS 41</p>	<p>Dielectric Adapter</p>  <p>DA 44</p>	<p>Dielectric Union</p>  <p>DU 44</p>

Visual Index

Tube to Welded Systems

Tube Socket Weld Union

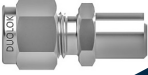

TSWU 45

Tube Socket Weld Elbow



TSWE 45

Male Pipe Weld Connector

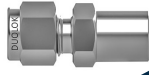

MPWC 46

Male Pipe Weld Elbow



MPWE 47

Tube Stub Connectors / Adapters

Reducer / Adapter



R 48-49

Bulkhead Reducer / Adapter

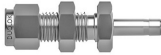

BR 47

Port Connector



PC 52

Reducing Port Connector



RPC 52

Male Adapter



MA 50

Female Adapter

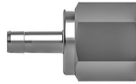

FA 51

Calibration Union





CU 53

Hose Barb Adapter





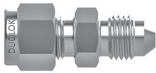
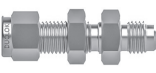



HBA 53

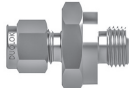
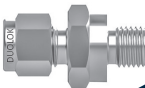

Duolok to 37° Flare (AN)







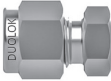

<p>AN Union</p>  <p>ANU 54</p>	<p>AN Bulkhead Union</p>  <p>ANBU 54</p>	<p>Female AN Adapter</p>  <p>ANF 54</p>
<p>AN Adapter</p>  <p>ANA 55</p>		

Tube to O-Ring Seal & Tube to SAE / MS

<p>O-Ring Seal Male Connector</p>  <p>OMC 55</p>	<p>O-Ring Seal Straight Connector</p>  <p>OSC 55</p>	<p>Male Connector to Straight Thread Boss</p>  <p>MCST 56</p>
<p>Male Elbow to Straight Thread Boss</p>  <p>MEST 56</p>	<p>45° Male Elbow to Straight Thread Boss</p>  <p>M45EST 57</p>	<p>Male Branch Tee to Straight Thread Boss</p>  <p>MBTST 57</p>
<p>Male Run Tee to Straight Thread Boss</p>  <p>MRTST 58</p>	<p>Male Adapter to Straight Thread Boss</p>  <p>MAST 58</p>	

Visual Index

Cap and Plug	
Cap  CP 59	Plug  P 60

Components		
Nut  N 61	Back Ferrule  BF 62	Front Ferrule  FF 63
Ferrule Set  FS 63	Knurled Nut  KN 64	Bulkhead Locknut  BN 64
Fitting Gasket  RG 64	Tube Insert  TI 65	Bonded Washer  DW 65

Installation Instructions

Initial Installation

- ① SSP tube fittings come individually bagged and completely assembled for immediate use. There is no need for disassembly prior to use. Simply remove the tube fitting from its bag, insert the tube* until it bottoms in the SSP tube fitting body and then hand tighten the SSP nut. (See Figure 02.)

**Tubing ends should be cut as straight as possible with all O.D. and I.D. burrs removed. Use of a tubing cutter or guide blocks with a hack-saw is recommended.*

Figure 02.

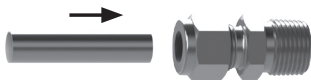

NOTE: For extreme system applications using high pressures or requiring an extra factor of safety, it may be desirable to use a “common make up starting point” to alleviate the inherent variations in tubing diameters. Installation should begin from a snug position, which is achieved by wrench tightening the Duolok nut until the inserted tubing will not move by hand (approximately 1/8 turn). From this new “snug” starting point, continue with the recommended installation instructions.

- ② While holding the fitting body stable with a back-up wrench, scribe the nut for a reference point and wrench tighten the nut 1-1/4 turns for sizes 1/4"-1" or 6mm-25mm and 3/4 turn for sizes 1/16"-3/16" or 3mm-5mm. (See Figures 03 and 04).

NOTE: For all sizes, tighten plugs (P), machined ferrule end of port connector (PC) and the SSP tube fitting end of the Female AN adapter (ANF) only 1/4 of a turn. Tube fittings in sizes over 25mm and 1in. require the use of the SSP Hydraulic Swaging Tool for installation. Contact your local SSP Distributor for more information.

Installation Instructions

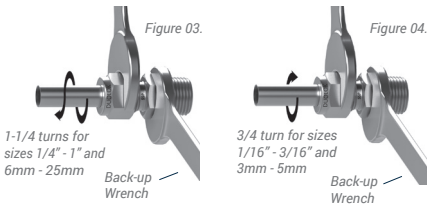

Reassembly Instructions

- 1 To reassemble a SSP tube fitting connection, simply insert the tubing with the previously coined ferrules and SSP nut into the fitting body until the front ferrule seats within the fitting body, and then tighten the nut by hand. (See Figure 05.)

Figure 05.

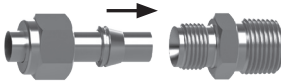

NOTE: By following proper reassembly procedures, SSP tube fitting connections may be disconnected and reconnected repeatedly.

- 2 While holding the fitting body stable with a back up wrench, use a wrench to rotate the SSP nut to the fitting's original installation position (approximately 1/4 turn from the hand-tight, snug position) then continue to tighten the SSP nut slightly. (See Figure 06.)

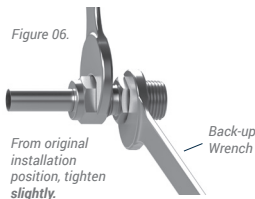

Installation Instructions

Component Assembly

Should individual component assembly of an SSP tube fitting ever be required, careful attention must be given to the proper sequence and direction of the SSP tube fitting components. (See Figure 07.)

Figure 07.

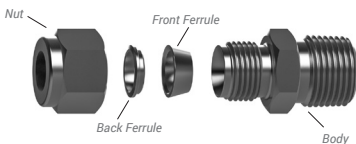

Pre-setting

The SSP tube fitting pre-setting tool is used to preset the ferrules on the tubing for subsequent installation in a fitting body. The pre-setting tool can be especially helpful when an installation must be made in a tight space or hard-to-work area. The pre-setting tool allows the major portion of the installation work to occur in a more favorable work setting with only the completion of the installation in the hard-to-work area.

Pre-setting Instructions

- 1 Secure the pre-setting tool in a vise.
- 2 Remove the protective nut and assemble the SSP nut and ferrules loosely to the pre-setting tool. Insert the tubing through the nut and ferrules until it bottoms in the pre-setting tool, and then follow the standard SSP tube fitting installation instructions from page 7. (See Figures 08a and 08b.)

Figure 08a.

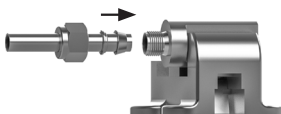
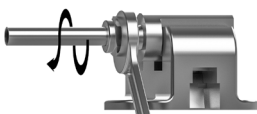

Figure 08b.



Installation Instructions

- Loosen the nut and remove the tubing with the pre-set SSP tube fitting ferrules and nut from the pre-setting tool. (See Figure 09.)

Figure 09.

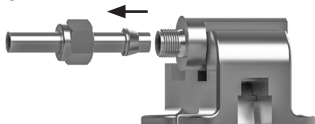

- Installation of the tubing, with the pre-set SSP tube fitting ferrules and nut in the appropriate fitting body, can now be made by following the standard reassembly instructions. (See Figures 10a and 10b.)

Figure 10a.

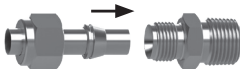
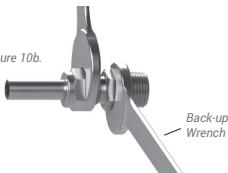

Figure 10b.



- Return the protective nut to the presetting tool.

NOTE: To extend the life of a pre-setting tool, lubricate the tool with a lubricant compatible with the system's tubing material, environment and media. Also, at times an over-sized or very soft tubing may tend to stick in the presetting tool after make up. To remove the tubing, gently rock the tubing back and forth. Never turn the tube with pliers or another tool as such action may damage the sealing surfaces.

Gageability

Each SSP tube fitting component is manufactured with utmost precision to provide the optimum performance interaction of the components during assembly. By maintaining such stringent manufacturing tolerances, SSP tube fittings are considered gageable for sufficient pull-up during initial installation. The SSP tube fitting “Gap Gages” are designed to identify for the installer or inspector, prior to pressurizing a system, that sufficient tightening of the tube fitting has occurred. Gageability provides additional reliability for proper installation and ultimate tube fitting safety and performance.

Gap Gage Instructions

- 1 Follow proper installation instructions (as supplied with the fittings, or published in the SSP tube fittings catalog).
- 2 After completion of the installation instructions and prior to pressuring the system, choose the proper size Gap Gage and try to insert it between the fitting’s nut and body hex. (See Figure 11a and 11b.)

Figure 11a.



No additional tightening required.

Figure 11b.

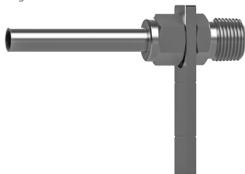

Additional tightening required.

Installation Instructions

- 3 If the Gap Gage will not enter between the fitting's nut and body hex, no additional tightening is required.
- 4 If the Gap Gage will enter between the fitting's nut and body hex, additional tightening is required.

Technical Data

STAINLESS STEEL TUBING – Wall Thickness .010" to .049" Maximum Allowable Working Pressure (PSIG)								
Tube O.D. Size (In.)	Wall Thickness of Tube (In.)							
	.010	.012	.014	.016	.020	.028	.035	.049
1/16	5600	6850	8150	9500	12100			
1/8						8550	11000	
3/16						5450	7000	10300
1/4						4000	5100	7500
5/16							4050	5850
3/8							3300	4800
1/2							2450	3500
5/8								2950
3/4								2400
7/8								2050
1		Note: For light gas service, use tubing with wall thickness outside of shaded area.						
1-1/4								
1-1/2								
2								

(Wall Thicknesses .065" through .188" are on the following page.)

Calculation Basis: Annealed, seamless 304 or 316 stainless steel tubing ASTM A-269 or equivalent. System temperatures between -20°F and 100°F with allowable stress of 20,000 psi. Ultimate tensile strength of 75,000 psi. Safety factor of 4.

Reference: ANSI B31.3 Code. (For more specific working pressure information regarding a particular tubing, consult with the actual manufacturer of the tubing.)

Note: For welded and drawn tubing, a derating factor must be utilized. For double welded tube, multiply the above pressure rating by .85; and for single welded tube by .80 (ANSI B 31, Table A-1B).

Suggested Tube Ordering Information: Specify the outside diameter and wall thickness of annealed, seamless or welded and drawn 316 or 304 stainless steel tubing of ASTM A-269, A-249, A-213 or equivalent. Also specify high quality tubing to be free of scratches and suited for bending with material hardness not to exceed Rb 90.

Technical Data

STAINLESS STEEL TUBING – Wall Thickness .065" to .188" Maximum Allowable Working Pressure (PSIG)								
Tube O.D. Size (In.)	Wall Thickness of Tube (In.)							
	.065	.083	.095	.109	.120	.134	.156	.188
1/16								
1/8					Note: For light gas service, use tubing with wall thickness outside of shaded area.			
3/16								
1/4	10300							
5/16	8050							
3/8	6550							
1/2	4750	6250						
5/8	4000	5200	6050					
3/4	3300	4250	4950	5800				
7/8	2800	3600	4200	4850				
1	2400	3150	3650	4200	4700			
1-1/4		2450	2850	3300	3650	4150	4900	
1-1/2			2350	2700	3000	3400	4000	4900
2				2000	2200	2500	2900	3600

(Wall Thicknesses .010" through .049" are on the previous page.)

Calculation Basis: Annealed, seamless 304 or 316 stainless steel tubing ASTM A-269 or equivalent. System temperatures between -20°F and 100°F with allowable stress of 20,000 psi. Ultimate tensile strength of 75,000 psi. Safety factor of 4.

Reference: ANSI B31.3 Code. (For more specific working pressure information regarding a particular tubing, consult with the actual manufacturer of the tubing.) Multiply stainless steel rating by 0.94 for working pressure in accordance with ASME B31.1.

Note: For welded and drawn tubing, a derating factor must be utilized. For double welded tube, multiply the above pressure rating by .85; and for single welded tube by .80 (ANSI B 31, Table A-1B).

Suggested Tube Ordering Information: Specify the outside diameter and wall thickness of annealed, seamless or welded and drawn 316 or 304 stainless steel tubing of ASTM A-269, A-249, A-213 or equivalent. Also specify high quality tubing to be free of scratches, and suited for bending with material hardness not to exceed Rb 90.

STAINLESS STEEL TUBING											
Maximum Allowable Working Pressure (bar)											
Tube O.D. Size (mm)	Wall Thickness of Tube (mm)										
	0.8	1.0	1.2	1.5	1.8	2.0	2.2	2.5	2.8	3.0	3.5
3	670										
6	310	420	540	710				Note: For light gas service, use tubing with wall thickness outside of shaded area.			
8		310	390	520							
10		240	300	400	510	580					
12		200	250	330	410	470					
14		160	200	270	340	380	430				
15		150	190	250	310	360	400				
16			170	230	290	330	370	400			
18			150	200	260	290	320	370			
20			140	180	230	260	290	330	380		
22			140	160	200	230	260	300	340		
25					180	200	230	260	290	320	

Calculation Basis: Annealed, seamless 304 or 316 stainless steel tubing EN ISO 1127 or equivalent (from ASME B31.3). System temperatures between -20°F and 100°F with allowable stress of 137 MPA. Ultimate tensile strength of 517 MPA. Safety factor of 4.

Reference: ANSI B31.3 Code. (For more specific working pressure information regarding a particular tubing, consult with the actual manufacturer of the tubing.) Multiply stainless steel rating by 0.94 for working pressure in accordance with ASME B31.1.

Note: For welded and drawn tubing, a derating factor must be utilized. For double welded tube, multiply the above pressure rating by .85; and for single welded tube .80 (ANSI B 31, Table A-1B).

Suggested Tube Ordering Information: Specify the outside diameter and wall thickness of annealed, seamless or welded and drawn 316 or 304 stainless steel tubing of EN ISO 1127 or equivalent. Also specify high quality tubing to be free of scratches, and suited for bending with material hardness not to exceed Rb 90 (200 HV).

Tube to Male Pipe

MC

Male Connector

- NPT

For Fractional Tube



Duolok Part #	Tube O.D. (in.)	NPT Male Pipe (in.)
D3MC2	3/16	1/8
D3MC4	3/16	1/4
D4MC2	1/4	1/8
D4MC4	1/4	1/4
D6MC2	3/8	1/8
D6MC4	3/8	1/4
D6MC6	3/8	3/8
D6MC8	3/8	1/2
D8MC2	1/2	1/8
D8MC4	1/2	1/4
D8MC6	1/2	3/8
D8MC8	1/2	1/2
D10MC2	5/8	1/8
D10MC4	5/8	1/4
D10MC6	5/8	3/8
D10MC8	5/8	1/2
D10MC12	5/8	3/4
D12MC2	3/4	1/8
D12MC4	3/4	1/4
D12MC6	3/4	3/8
D12MC8	3/4	1/2
D12MC12	3/4	3/4
D14MC4	7/8	1/4
D14MC6	7/8	3/8
D14MC8	7/8	1/2
D16MC6	1	3/8
D16MC8	1	1/2
D16MC12	1	3/4
D16MC16	1	1
D20MC16	1-1/4	1
D20MC20	1-1/4	1-1/4
D24MC24	1-1/2	1-1/2
D32MC32	2	2

Tube to Male Pipe

MC

Male Connector - NPT

For Metric Tube



Duolok Part #	Tube O.D. (mm)	NPT Male Pipe (in.)
DM3MC2	3	1/8
DM3MC4	3	1/4
DM4MC2	4	1/8
DM4MC4	4	1/4
DM6MC2	6	1/8
DM6MC4	6	1/4
DM6MC6	6	3/8
DM6MC8	6	1/2
DM8MC2	8	1/8
DM8MC4	8	1/4
DM8MC6	8	3/8
DM8MC8	8	1/2
DM10MC2	10	1/8
DM10MC4	10	1/4
DM10MC6	10	3/8
DM10MC8	10	1/2
DM10MC12	10	3/4
DM12MC2	12	1/8
DM12MC4	12	1/4
DM12MC6	12	3/8
DM12MC8	12	1/2
DM12MC12	12	3/4
DM14MC4	14	1/4
DM14MC6	14	3/8
DM14MC8	14	1/2
DM15MC8	15	1/2
DM16MC6	16	3/8
DM16MC8	16	1/2
DM16MC12	16	3/4
DM18MC8	18	1/2
DM18MC12	18	3/4
DM20MC8	20	1/2
DM20MC12	20	3/4
DM22MC12	22	3/4
DM22MC16	22	1
DM25MC8	25	1/2
DM25MC12	25	3/4
DM25MC16	25	1

Tube to Male Pipe

MCRS

Male

Connector -

ISO Parallel

For Fractional Tube

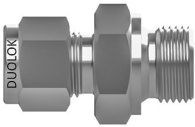

Duolok Part #	Tube O.D. (in.)	ISO Male Pipe (in.)
D2MCRS2	1/8	1/8
D2MCRS4	1/8	1/4
D2MCRS6	1/8	3/8
D4MCRS2	1/4	1/8
D4MCRS4	1/4	1/4
D4MCRS6	1/4	3/8
D4MCRS8	1/4	1/2
D6MCRS4	3/8	1/4
D6MCRS6	3/8	3/8
D6MCRS8	3/8	1/2
D8MCRS4	1/2	1/4
D8MCRS6	1/2	3/8
D8MCRS8	1/2	1/2
D12MCRS8	3/4	1/2
D12MCRS12	3/4	3/4
D16MCRS8	1	1/2
D16MCRS16	1	1

NOTE: RS threaded fittings conform to ISO standards 228-1. The standard gasket for RS fittings is a 300 series stainless steel outer ring with a Viton® inner ring bonded to it.

Tube to Male Pipe

MCRS

Male
Connector -
ISO Parallel
For Metric Tube

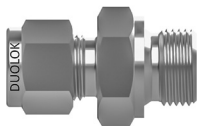

Duolok Part #	Tube O.D. (mm)	ISO Male Pipe (in.)
DM3MCRS2	3	1/8
DM3MCRS4	3	1/4
DM4MCRS2	4	1/8
DM6MCRS2	6	1/8
DM6MCRS4	6	1/4
DM6MCRS6	6	3/8
DM6MCRS8	6	1/2
DM8MCRS2	8	1/8
DM8MCRS4	8	1/4
DM8MCRS6	8	3/8
DM8MCRS8	8	1/2
DM10MCRS4	10	1/4
DM10MCRS6	10	3/8
DM10MCRS8	10	1/2
DM12MCRS4	12	1/4
DM12MCRS6	12	3/8
DM12MCRS8	12	1/2
DM12MCRS12	12	3/4
DM16MCRS6	16	3/8
DM16MCRS8	16	1/2
DM18MCRS8	18	1/2
DM18MCRS12	18	3/4
DM20MCRS8	20	1/2
DM20MCRS12	20	3/4
DM22MCRS12	22	3/4
DM22MCRS16	22	1
DM25MCRS12	25	3/4
DM25MCRS16	25	1

NOTE: RS threaded fittings conform to ISO standards 228-1. The standard gasket for RS fittings is a 300 series stainless steel outer ring with a Viton® inner ring bonded to it.

Tube to Male Pipe

MCRT

Male

Connector -

ISO Tapered

For Fractional Tube



Duolok Part #	Tube O.D. (in.)	ISO Male Pipe (in.)
D2MCRT2	1/8	1/8
D2MCRT4	1/8	1/4
D4MCRT2	1/4	1/8
D4MCRT4	1/4	1/4
D4MCRT6	1/4	3/8
D4MCRT8	1/4	1/2
D5MCRT2	5/16	1/8
D5MCRT4	5/16	1/4
D6MCRT2	3/8	1/8
D6MCRT4	3/8	1/4
D6MCRT6	3/8	3/8
D6MCRT8	3/8	1/2
D8MCRT4	1/2	1/4
D8MCRT6	1/2	3/8
D8MCRT8	1/2	1/2
D8MCRT12	1/2	3/4
D12MCRT12	3/4	3/4
D16MCRT16	1	1

NOTE: RT threaded fittings conform to ISO standards 7-1.

Tube to Male Pipe

MCRT

Male

Connector -
ISO Tapered
For Metric Tube



Duolok Part #	Tube O.D. (mm)	ISO Male Pipe (in.)
DM4MCRT2	4	1/8
DM4MCRT4	4	1/4
DM6MCRT2	6	1/8
DM6MCRT4	6	1/4
DM6MCRT6	6	3/8
DM6MCRT8	6	1/2
DM8MCRT2	8	1/8
DM8MCRT4	8	1/4
DM8MCRT6	8	3/8
DM8MCRT8	8	1/2
DM10MCRT2	10	1/8
DM10MCRT4	10	1/4
DM10MCRT6	10	3/8
DM10MCRT8	10	1/2
DM12MCRT4	12	1/4
DM12MCRT6	12	3/8
DM12MCRT8	12	1/2
DM12MCRT12	12	3/4
DM15MCRT8	15	1/2
DM16MCRT4	16	1/4
DM16MCRT6	16	3/8
DM16MCRT8	16	1/2
DM16MCRT12	16	3/4
DM18MCRT8	18	1/2
DM18MCRT12	18	3/4
DM20MCRT8	20	1/2
DM20MCRT12	20	3/4
DM22MCRT8	22	1/2
DM22MCRT12	22	3/4
DM25MCRT8	25	1/2
DM25MCRT12	25	3/4

NOTE: RT threaded fittings conform to ISO standards 7-1.

Tube to Male Pipe

MCBT

*Male Connector
Bored Through
- NPT*

For Fractional Tube



Duolok Part #	Tube O.D. (in.)	NPT Male Pipe (in.)
D1MCBT1	1/16	1/16
D1MCBT2	1/16	1/8
D2MCBT1	1/8	1/16
D2MCBT2	1/8	1/8
D2MCBT4	1/8	1/4
D3MCBT2	3/16	1/8
D3MCBT4	3/16	1/4
D4MCBT2	1/4	1/8
D4MCBT4	1/4	1/4
D4MCBT6	1/4	3/8
D4MCBT8	1/4	1/2
D5MCBT4	5/16	1/4
D6MCBT4	3/8	1/4
D6MCBT6	3/8	3/8
D6MCBT8	3/8	1/2
D8MCBT8	1/2	1/2
D10MCBT12	5/8	3/4
D12MCBT12	3/4	3/4
D16MCBT16	1	1
D20MCBT20	1-1/4	1-1/4

Tube to Male Pipe

BMC

*Bulkhead Male
Connector - NPT
For Fractional Tube*

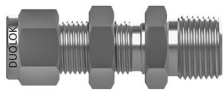

Duolok Part #	Tube O.D. (in.)	NPT Male Pipe (in.)
D2BMC2	1/8	1/8
D4BMC2	1/4	1/8
D4BMC4	1/4	1/4
D6BMC4	3/8	1/4
D8BMC6	1/2	3/8
D8BMC8	1/2	1/2

M45E

*45° Male Elbow
- NPT
For Fractional Tube*

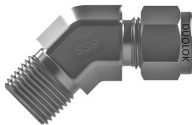

Duolok Part #	Tube O.D. (in.)	NPT Male Pipe (in.)
D4M45E2	1/4	1/8
D4M45E4	1/4	1/4
D6M45E2	3/8	1/8
D6M45E4	3/8	1/4
D6M45E6	3/8	3/8
D8M45E6	1/2	3/8

Tube to Male Pipe

ME

Male Elbow

- NPT

For Fractional Tube



Duolok Part #	Tube O.D. (in.)	NPT Male Pipe (in.)
D1ME1	1/16	1/16
D1ME2	1/16	1/8
D2ME1	1/8	1/16
D2ME2	1/8	1/8
D2ME4	1/8	1/4
D3ME2	3/16	1/8
D3ME4	3/16	1/4
D4ME2	1/4	1/8
D4ME4	1/4	1/4
D4ME6	1/4	3/8
D4ME8	1/4	1/2
D5ME2	5/16	1/8
D5ME4	5/16	1/4
D5ME6	5/16	3/8
D6ME2	3/8	1/8
D6ME4	3/8	1/4
D6ME6	3/8	3/8
D6ME8	3/8	1/2
D6ME12	3/8	3/4
D8ME4	1/2	1/4
D8ME6	1/2	3/8
D8ME8	1/2	1/2
D8ME12	1/2	3/4
D10ME6	5/8	3/8
D10ME8	5/8	1/2
D10ME12	5/8	3/4
D12ME8	3/4	1/2
D12ME12	3/4	3/4
D14ME12	7/8	3/4
D16ME12	1	3/4
D16ME16	1	1
D20ME20	1-1/4	1-1/4
D24ME24	1-1/2	1-1/2
D32ME32	2	2

Tube to Male Pipe

ME

Male Elbow

- NPT

For Metric Tube



Duolok Part #	Tube O.D. (mm)	NPT Male Pipe (in.)
DM3ME2	3	1/8
DM3ME4	3	1/4
DM4ME2	4	1/8
DM4ME4	4	1/4
DM6ME2	6	1/8
DM6ME4	6	1/4
DM6ME6	6	3/8
DM6ME8	6	1/2
DM8ME2	8	1/8
DM8ME4	8	1/4
DM8ME6	8	3/8
DM8ME8	8	1/2
DM10ME2	10	1/8
DM10ME4	10	1/4
DM10ME6	10	3/8
DM10ME8	10	1/2
DM12ME4	12	1/4
DM12ME6	12	3/8
DM12ME8	12	1/2
DM12ME12	12	3/4
DM15ME8	15	1/2
DM16ME6	16	3/8
DM16ME8	16	1/2
DM16ME12	16	3/4
DM18ME8	18	1/2
DM18ME12	18	3/4
DM20ME8	20	1/2
DM20ME12	20	3/4
DM22ME12	22	3/4
DM22ME16	22	1
DM25ME12	25	3/4
DM25ME16	25	1

Tube to Male Pipe

MERS

Male Elbow -
ISO Parallel

For Fractional Tube



Duolok Part #	Tube O.D. (mm)	ISO Male Pipe (in.)
D4MERS2	1/4	1/8
D4MERS4	1/4	1/4
D6MERS4	3/8	1/4
D6MERS6	3/8	3/8
D8MERS4	1/2	1/4
D8MERS6	1/2	3/8
D8MERS8	1/2	1/2

NOTE: RS threaded fittings conform to ISO standards 228/1. The standard gasket for RS fittings is a 300 series stainless steel outer ring with a Viton® inner ring bonded to it.

MERS

Male Elbow -
ISO Parallel

For Metric Tube



Duolok Part #	Tube O.D. (mm)	ISO Male Pipe (in.)
DM6MERS2	6	1/8
DM6MERS4	6	1/4
DM8MERS2	8	1/8
DM8MERS4	8	1/4
DM10MERS4	10	1/4
DM10MERS6	10	3/8
DM12MERS4	12	1/4
DM12MERS6	12	3/8
DM12MERS8	12	1/2
DM12MERS12	12	3/4

MERT

Male Elbow -
ISO Tapered

For Fractional Tube



Duolok Part #	Tube O.D. (in.)	ISO Male Pipe (in.)
D2MERT2	1/8	1/8
D4MERT2	1/4	1/8
D4MERT4	1/4	1/4
D4MERT6	1/4	3/8
D4MERT8	1/4	1/2
D5MERT4	5/16	1/4
D6MERT2	3/8	1/8
D6MERT4	3/8	1/4
D6MERT6	3/8	3/8
D6MERT8	3/8	1/2
D8MERT4	1/2	1/4
D8MERT6	1/2	3/8
D8MERT8	1/2	1/2

NOTE: RT threaded fittings conform to ISO standards 7-1.

Tube to Male Pipe

MERT

Male Elbow -
ISO Tapered
For Metric Tube



Duolok Part #	Tube O.D. (mm)	ISO Male Pipe (in.)
DM3MERT2	3	1/8
DM3MERT4	3	1/4
DM4MERT2	4	1/8
DM4MERT4	4	1/4
DM6MERT2	6	1/8
DM6MERT4	6	1/4
DM6MERT6	6	3/8
DM6MERT8	6	1/2
DM8MERT2	8	1/8
DM8MERT4	8	1/4
DM8MERT6	8	3/8
DM8MERT8	8	1/2
DM10MERT4	10	1/4
DM10MERT6	10	3/8
DM10MERT8	10	1/2
DM12MERT2	12	1/8
DM12MERT4	12	1/4
DM12MERT6	12	3/8
DM12MERT8	12	1/2
DM12MERT12	12	3/4
DM16MERT6	16	3/8
DM16MERT8	16	1/2
DM18MERT8	18	1/2
DM18MERT12	18	3/4
DM20MERT8	20	1/2
DM20MERT12	20	3/4
DM22MERT12	22	3/4
DM22MERT16	22	1
DM25MERT12	25	3/4
DM25MERT16	25	1

NOTE: RT threaded fittings conform to ISO standards 7-1.

Tube to Male Pipe

MBT

Male Branch Tee

- NPT

For Fractional Tube



Duolok Part #	Tube O.D. (in.)	NPT Male Pipe (in.)
D2MBT2	1/8	1/8
D2MBT4	1/8	1/4
D3MBT2	3/16	1/8
D4MBT2	1/4	1/8
D4MBT4	1/4	1/4
D5MBT2	5/16	1/8
D6MBT4	3/8	1/4
D6MBT6	3/8	3/8
D8MBT6	1/2	3/8
D8MBT8	1/2	1/2
D10MBT8	5/8	1/2
D12MBT12	3/4	3/4

MBT

Male Branch Tee

- NPT

For Metric Tube



Duolok Part #	Tube O.D. (mm)	NPT Male Pipe (in.)
DM6MBT2	6	1/8
DM6MBT4	6	1/4
DM8MBT2	8	1/8
DM8MBT4	8	1/4
DM10MBT4	10	1/4
DM12MBT4	12	1/4
DM12MBT6	12	3/8
DM12MBT8	12	1/2
DM16MBT8	16	1/2

Tube to Male Pipe

MRT

Male Run Tee

- NPT

For Fractional Tube



Duolok Part #	Tube O.D. (in.)	NPT Male Pipe (in.)
D2MRT2	1/8	1/8
D2MRT4	1/8	1/4
D3MRT2	3/16	1/8
D4MRT2	1/4	1/8
D4MRT4	1/4	1/4
D5MRT2	5/16	1/8
D6MRT4	3/8	1/4
D6MRT6	3/8	3/8
D8MRT6	1/2	3/8
D8MRT8	1/2	1/2
D10MRT8	5/8	1/2
D12MRT12	3/4	3/4

MRT

Male Run Tee

- NPT

For Metric Tube



Duolok Part #	Tube O.D. (mm)	NPT Male Pipe (in.)
DM6MRT2	6	1/8
DM6MRT4	6	1/4
DM8MRT4	8	1/4
DM12MBT4	12	1/4
DM12MBT8	12	1/2
DM16MBT8	16	1/2

Tube to Female Pipe

FC

*Female
Connector
- FNPT*

For Fractional Tube

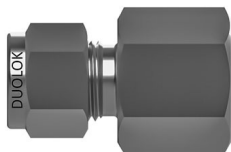

Duolok Part #	Tube O.D. (in.)	NPT Female Pipe (in.)
D1FC1	1/16	1/16
D1FC2	1/16	1/8
D2FC2	1/8	1/8
D2FC4	1/8	1/4
D3FC2	3/16	1/8
D4FC2	1/4	1/8
D4FC4	1/4	1/4
D4FC6	1/4	3/8
D4FC8	1/4	1/2
D5FC2	5/16	1/8
D5FC4	5/16	1/4
D6FC2	3/8	1/8
D6FC4	3/8	1/4
D6FC6	3/8	3/8
D6FC8	3/8	1/2
D6FC12	3/8	3/4
D8FC4	1/2	1/4
D8FC6	1/2	3/8
D8FC8	1/2	1/2
D8FC12	1/2	3/4
D10FC6	5/8	3/8
D10FC8	5/8	1/2
D12FC8	3/4	1/2
D12FC12	3/4	3/4
D14FC12	7/8	3/4
D16FC12	1	3/4
D16FC16	1	1
D20FC20	1-1/4	1-1/4
D24FC24	1-1/2	1-1/2
D32FC32	2	2

Tube to Female Pipe

FC

*Female
Connector
- FNPT
For Metric Tube*

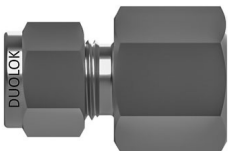

Duolok Part #	Tube O.D. (mm)	NPT Female Pipe (in.)
DM3FC2	3	1/8
DM3FC4	3	1/4
DM4FC2	4	1/8
DM6FC2	6	1/8
DM6FC4	6	1/4
DM6FC6	6	3/8
DM6FC8	6	1/2
DM8FC2	8	1/8
DM8FC4	8	1/4
DM8FC6	8	3/8
DM8FC8	8	1/2
DM10FC4	10	1/4
DM10FC6	10	3/8
DM10FC8	10	1/2
DM12FC4	12	1/4
DM12FC6	12	3/8
DM12FC8	12	1/2
DM15FC8	15	1/2
DM16FC8	16	1/2
DM20FC8	20	1/2
DM20FC12	20	3/4
DM22FC12	22	3/4
DM22FC16	22	1
DM25FC12	25	3/4
DM25FC16	25	1

Tube to Female Pipe

BFC

Bulkhead Female Connector - FNPT

For Fractional Tube

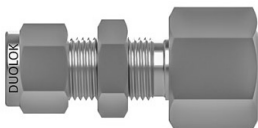

Duolok Part #	Tube O.D. (in.)	NPT Female Pipe (in.)
D2BFC2	1/8	1/8
D4BFC2	1/4	1/8
D4BFC4	1/4	1/4
D6BFC4	3/8	1/4
D8BFC6	1/2	3/8
D8BFC8	1/2	1/2

FCRG

Female Connector - ISO parallel

For Metric Tube

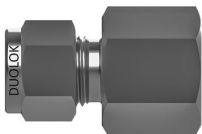

Duolok Part #	Tube O.D. (mm)	ISO Female Pipe (in.)
DM3FCRG4	3	1/4
DM6FCRG4	6	1/4
DM6FCRG6	6	3/8
DM6FCRG8	6	1/2
DM8FCRG4	8	1/4
DM8FCRG6	8	3/8
DM8FCRG8	8	1/2
DM10FCRG4	10	1/4
DM10FCRG6	10	3/8
DM10FCRG8	10	1/2
DM12FCRG4	12	1/4
DM12FCRG6	12	3/8
DM12FCRG8	12	1/2
DM20FCRG8	20	1/2
DM22FCRG8	22	1/2

NOTE: No seal is made with the mating male thread. Instead, an RG gasket is placed in the flat bottom of the female end and the end of the mating male thread compresses against the RG gasket to seal. See page 64 for gasket seal numbers.

Tube to Female Pipe

FCRT

*Female
Connector -
ISO Tapered*

For Metric Tube



Duolok Part #	Tube O.D. (mm)	ISO Female Pipe (in.)
DM3FCRT2	3	1/8
DM6FCRT2	6	1/8
DM6FCRT4	6	1/4
DM6FCRT6	6	3/8
DM6FCRT8	6	1/2
DM8FCRT2	8	1/8
DM8FCRT4	8	1/4
DM8FCRT6	8	3/8
DM8FCRT8	8	1/2
DM10FCRT2	10	1/8
DM10FCRT4	10	1/4
DM10FCRT6	10	3/8
DM10FCRT8	10	1/2
DM12FCRT2	12	1/8
DM12FCRT4	12	1/4
DM12FCRT6	12	3/8
DM12FCRT8	12	1/2
DM12FCRT12	12	3/4
DM15FCRT6	15	3/8
DM15FCRT8	15	1/2
DM20FCRT8	20	1/2
DM20FCRT12	20	3/4
DM22FCRT12	22	3/4
DM22FCRT16	22	1
DM25FCRT12	25	3/4
DM25FCRT16	25	1

NOTE: RT threaded fittings conform to ISO standard 7-1.

Tube to Female Pipe

FE

Female Elbow - FNPT

For Fractional Tube



Duolok Part #	Tube O.D. (in.)	NPT Female Pipe (in.)
D2FE2	1/8	1/8
D2FE4	1/8	1/4
D3FE2	3/16	1/8
D4FE2	1/4	1/8
D4FE4	1/4	1/4
D4FE6	1/4	3/8
D4FE8	1/4	1/2
D5FE2	5/16	1/8
D5FE4	5/16	1/4
D6FE2	3/8	1/8
D6FE4	3/8	1/4
D6FE6	3/8	3/8
D6FE8	3/8	1/2
D8FE4	1/2	1/4
D8FE6	1/2	3/8
D8FE8	1/2	1/2
D10FE6	5/8	3/8
D10FE8	5/8	1/2
D12FE8	3/4	1/2
D12FE12	3/4	3/4
D14FE12	7/8	3/4
D16FE12	1	3/4
D16FE16	1	1

FE

Female Elbow - FNPT

For Metric Tube



Duolok Part #	Tube O.D. (mm)	NPT Female Pipe (in.)
DM6FE2	6	1/8
DM6FE4	6	1/4
DM6FE8	6	1/2
DM8FE4	8	1/4
DM10FE2	10	1/8
DM10FE4	10	1/4
DM12FE4	12	1/4
DM12FE8	12	1/2
DM16FE8	16	1/2

Tube to Female Pipe

FBT

Female Branch Tee - FNPT

For Fractional Tube



Duolok Part #	Tube O.D. (in.)	NPT Female Pipe (in.)
D2FBT2	1/8	1/8
D4FBT2	1/4	1/8
D4FBT4	1/4	1/4
D6FBT4	3/8	1/4
D8FBT4	1/2	1/4
D8FBT6	1/2	3/8
D8FBT8	1/2	1/2
D10FBT8	5/8	1/2
D12FBT12	3/4	3/4
D16FBT12	1	3/4
D16FBT16	1	1

FBT

Female Branch Tee - FNPT

For Metric Tube



Duolok Part #	Tube O.D. (mm)	NPT Female Pipe (in.)
DM6FBT4	6	1/4
DM8FBT2	8	1/8
DM8FBT4	8	1/4
DM10FBT4	10	1/4
DM12FBT4	12	1/4
DM12FBT6	12	3/8
DM16FBT8	16	1/2

Tube to Female Pipe

FRT

Female Run Tee

- FNPT

For Fractional Tube



Duolok Part #	Tube O.D. (in.)	NPT Female Pipe (in.)
D2FRT2	1/8	1/8
D4FRT2	1/4	1/8
D4FRT4	1/4	1/4
D6FRT4	3/8	1/4
D8FRT6	1/2	3/8
D8FRT8	1/2	1/2
D12FRT12	3/4	3/4

FRT

Female Run Tee

- FNPT

For Metric Tube



Duolok Part #	Tube O.D. (mm)	NPT Female Pipe (in.)
DM6FRT2	6	1/8
DM6FRT4	6	1/4
DM8FRT2	8	1/8
DM8FRT4	8	1/4
DM10FRT4	10	1/4
DM12FRT4	12	1/4
DM12FRT6	12	3/8
DM16FRT8	16	1/2

Tube to Tube Union

U

Union

For Fractional Tube

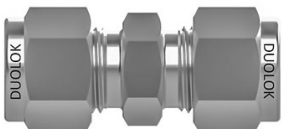

Duolok Part #	Tube O.D. (in.)
D1U	1/16
D2U	1/8
D3U	3/16
D4U	1/4
D5U	5/16
D6U	3/8
D8U	1/2
D10U	5/8
D12U	3/4
D14U	7/8
D16U	1
D20U	1-1/4
D24U	1-1/2
D32U	2

U

Union

For Metric Tube

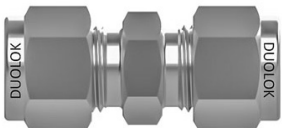

Duolok Part #	Tube O.D. (mm)
DM3U	3
DM4U	4
DM6U	6
DM8U	8
DM10U	10
DM12U	12
DM14U	14
DM15U	15
DM16U	16
DM18U	18
DM20U	20
DM22U	22
DM25U	25

Tube to Tube Union

BU

Bulkhead Union

For Fractional Tube

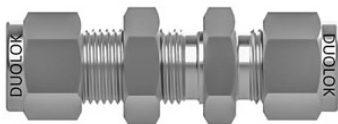

Duolok Part #	Tube O.D. (in.)
D1BU	1/16
D2BU	1/8
D3BU	3/16
D4BU	1/4
D5BU	5/16
D6BU	3/8
D8BU	1/2
D10BU	5/8
D12BU	3/4
D16BU	1

BU

Bulkhead Union

For Metric Tube

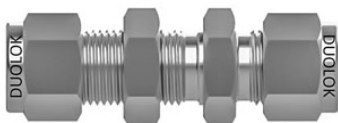

Duolok Part #	Tube O.D. (mm)
DM3BU	3
DM4BU	4
DM6BU	6
DM8BU	8
DM10BU	10
DM12BU	12
DM14BU	14
DM15BU	15
DM16BU	16
DM18BU	18
DM20BU	20

BRU

Bulkhead

Reducing Union

For Fractional Tube

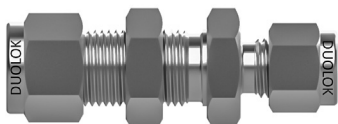

Duolok Part #	Tube 1 O.D. (in.)	Tube 2 O.D. (in.)
D4BRU2	1/4	1/8
D6BRU4	3/8	1/4
D8BRU4	1/2	1/4
D8BRU6	1/2	3/8

Tube to Tube Union

RU

Reducing Union

For Fractional Tube

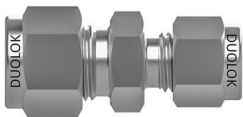

Duolok Part #	Tube 1 O.D. (in.)	Tube 2 O.D. (in.)
D2RU1	1/8	1/16
D3RU1	3/16	1/16
D3RU2	3/16	1/8
D4RU1	1/4	1/16
D4RU2	1/4	1/8
D4RU3	1/4	3/16
D5RU2	5/16	1/8
D5RU4	5/16	1/4
D6RU1	3/8	1/16
D6RU2	3/8	1/8
D6RU4	3/8	1/4
D6RU5	3/8	5/16
D8RU2	1/2	1/8
D8RU4	1/2	1/4
D8RU6	1/2	3/8
D10RU6	5/8	3/8
D10RU8	5/8	1/2
D12RU4	3/4	1/4
D12RU6	3/4	3/8
D12RU8	3/4	1/2
D12RU10	3/4	5/8
D16RU8	1	1/2
D16RU12	1	3/4

RU

Reducing Union

For Metric Tube

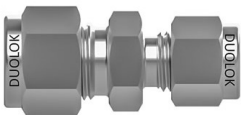

Duolok Part #	Tube 1 O.D. (mm)	Tube 2 O.D. (mm)
DM6RUM3	6	3
DM6RUM4	6	4
DM8RUM6	8	6
DM10RUM6	10	6
DM10RUM8	10	8
DM12RUM6	12	6
DM12RUM8	12	8
DM12RUM10	12	10
DM16RUM10	16	10
DM16RUM12	16	12
DM18RUM12	18	12
DM25RUM18	25	18
DM25RUM20	25	20

Tube to Tube Union

UE

Union Elbow

For Fractional Tube



Duolok Part #	Tube O.D. (in.)
D1UE	1/16
D2UE	1/8
D3UE	3/16
D4UE	1/4
D5UE	5/16
D6UE	3/8
D8UE	1/2
D10UE	5/8
D12UE	3/4
D14UE	7/8
D16UE	1
D20UE	1-1/4
D24UE	1-1/2
D32UE	2

UE

Union Elbow

For Metric Tube



Duolok Part #	Tube O.D. (mm)
DM3UE	3
DM4UE	4
DM6UE	6
DM8UE	8
DM10UE	10
DM12UE	12
DM14UE	14
DM15UE	15
DM16UE	16
DM18UE	18
DM20UE	20
DM22UE	22
DM25UE	25

Tube to Tube Union

UCS

Union Cross

For Fractional Tube



Duolok Part #	Tube O.D. (in.)
D2UCS	1/8
D4UCS	1/4
D5UCS	5/16
D6UCS	3/8
D8UCS	1/2
D12UCS	3/4
D16UCS	1

UCS

Union Cross

For Metric Tube



Duolok Part #	Tube O.D. (mm)
DM3UCS	3
DM6UCS	6
DM8UCS	8
DM10UCS	10
DM12UCS	12
DM16UCS	16
DM18UCS	18
DM20UCS	20
DM25UCS	25

Tube to Tube Union

UT

Union Tee

For Fractional Tube



Duolok Part #	Tube O.D. (in.)
D1UT	1/16
D2UT	1/8
D3UT	3/16
D4UT	1/4
D5UT	5/16
D6UT	3/8
D8UT	1/2
D10UT	5/8
D12UT	3/4
D14UT	7/8
D16UT	1
D20UT	1-1/4
D24UT	1-1/2
D32UT	2

UT

Union Tee

For Metric Tube



Duolok Part #	Tube O.D. (mm)
DM3UT	3
DM4UT	4
DM6UT	6
DM8UT	8
DM10UT	10
DM12UT	12
DM14UT	14
DM15UT	15
DM16UT	16
DM18UT	18
DM20UT	20
DM22UT	22
DM25UT	25

Tube to Tube Union

RUT

Reducing
Union Tee -
Configuration A
For Fractional Tube



Duolok Part #	Tube 1 O.D. (in.)	Tube 2 O.D. (in.)
D6RUT64	3/8	1/4
D8RUT84	1/2	1/4
D8RUT86	1/2	3/8
D10RUT106	5/8	3/8
D12RUT126	3/4	3/8
D12RUT128	3/4	1/2
D16RUT166	1	3/8
D16RUT168	1	1/2
D16RUT1612	1	3/4

RUT

Reducing
Union Tee -
Configuration B
For Fractional Tube

Duolok Part #	Tube 1 O.D. (in.)	Tube 2 O.D. (in.)
D6RUT46	3/8	1/4

RUT

Reducing
Union Tee -
Configuration C
For Fractional Tube

Duolok Part #	Tube 1 O.D. (in.)	Tube 2 O.D. (in.)
D8RUT66	1/2	3/8
D10RUT66	5/8	3/8
D12RUT66	3/4	3/8

RUT

Reducing
Union Tee -
Configuration D
For Fractional Tube

Duolok Part #	Tube 1 O.D. (in.)	Tube 2 O.D. (in.)	Tube 3 O.D. (in.)
D10RUT86	5/8	1/2	3/8
D12RUT86	3/4	1/2	3/8
D16RUT126	1	3/4	3/8

Tube to Tube Union

DA

Dielectric Adapter

For Fractional Tube

Duolok Part #	Tube End 1 (in.)	Tube End 2 (in.)
D8DA6	3/8	1/2



The SSP Instrumentation Dielectric Adapter is supplied with pre-swaged 3/8" nut and ferrules. The dielectric connection has a captive 1/2" nut. Dielectric Stop Collar and assembly instructions are also supplied with the adapter. By using 3/8" and 1/2" tube-ended SSP Instrumentation tube fittings with the adapter, a wide range of dielectric fitting configurations can be built.

DU

Dielectric Union

For Fractional Tube

Duolok Part #	Length (in.)
D4DU	4.08
D6DU	4.20
D8DU	4.48
D6DMC4	4.04



Dielectric fittings are designed to isolate monitoring and control instruments and equipment from electrical current and voltages. Manufactured in 316 stainless steel with thermoplastic insulators, SSP Instrumentation's dielectric fittings provide high dielectric strength in applications up to 5,000 PSIG. Typical applications for dielectric fittings are on impulse lines in natural gas pipeline monitoring stations. For additional factory assembled configurations, contact your local distributor.

Materials and Technical Data

Body: 316 Stainless Steel

Insulator: Polyetherimide

Pressure Rating: 5,000 PSIG

Temperature Rating: From -40°F to +200°F

Electrical Resistance: 1.0 x 10E7 Ohm at 70°F (20°C) at 10 VDC

@ 50% relative humidity; voltage breakdown resistance of 3,000 VDC.

Tube to Welded Systems

TSWU

Tube Socket Weld Connector

For Fractional Tube

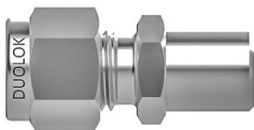

Duolok Part #	Tube Size (in.)
D2TSWU2	1/8
D4TSWU4	1/4
D6TSWU6	3/8
D8TSWU8	1/2
D12TSWU12	3/4
D16TSWU16	1

TSWE

Tube Socket Weld Elbow

For Fractional Tube



Duolok Part #	Tube Size (in.)
D4TSWE4	1/4
D6TSWE6	3/8
D8TSWE8	1/2

Tube to Welded Systems

MPWC

Male Pipe Weld Connector

For Fractional Tube



Duolok Part #	Tube O.D. (in.)	Male Pipe Weld Size (in.)
D2MPWC2	1/8	1/8
D3MPWC2	3/16	1/8
D4MPWC2	1/4	1/8
D4MPWC4	1/4	1/4
D5MPWC2	5/16	1/8
D5MPWC4	5/16	1/4
D6MPWC4	3/8	1/4
D6MPWC6	3/8	3/8
D6MPWC8	3/8	1/2
D8MPWC6	1/2	3/8
D8MPWC8	1/2	1/2
D8MPWC12	1/2	3/4
D10MPWC8	5/8	1/2
D12MPWC12	3/4	3/4
D16MPWC16	1	1
D20MPWC20	1-1/4	1-1/4
D24MPWC24	1-1/2	1-1/2

MPWC

Male Pipe Weld Connector

For Metric Tube



Duolok Part #	Tube O.D. (mm)	Male Pipe Weld Size (in.)
DM3MPWC2	3	1/8
DM4MPWC2	4	1/8
DM6MPWC2	6	1/8
DM6MPWC4	6	1/4
DM8MPWC2	8	1/8
DM8MPWC4	8	1/4
DM8MPWC8	8	1/2
DM10MPWC4	10	1/4
DM10MPWC6	10	3/8
DM10MPWC8	10	1/2
DM12MPWC4	12	1/4
DM12MPWC6	12	3/8
DM12MPWC8	12	1/2
DM14MPWC6	14	3/8
DM15MPWC8	15	1/2
DM16MPWC8	16	1/2
DM18MPWC8	18	1/2

Tube to Welded Systems

MPWE

*Male Pipe
Weld Elbow*

For Fractional Tube



Duolok Part #	Tube O.D. (in.)	Male Pipe Weld Size (in.)
D4MPWE2	1/4	1/8
D4MPWE4	1/4	1/4
D6MPWE4	3/8	1/4
D8MPWE8	1/2	1/2
D12MPWE12	3/4	3/4

Tube Stub Connectors / Adapters

BR

*Bulkhead Reducer /
Adapter*

For Fractional Tube



Duolok Part #	Tube O.D. (in.)
D2BR2	1/8
D4BR4	1/4
D6BR6	3/8
D8BR8	1/2

Tube Stub Connectors / Adapters

R

Reducer / Adapter

For Fractional Tube



Duolok Part #	Tube 1 O.D. (in.)	Tube 2 O.D. (in.)
D1R2	1/16	1/8
D1R4	1/16	1/4
D2R1	1/8	1/16
D2R2	1/8	1/8
D2R3	1/8	3/16
D2R4	1/8	1/4
D2R6	1/8	3/8
D2R8	1/8	1/2
D3R2	3/16	1/8
D3R4	3/16	1/4
D4R2	1/4	1/8
D4R3	1/4	3/16
D4R4	1/4	1/4
D4R5	1/4	5/16
D4R6	1/4	3/8
D4R8	1/4	1/2
D4R10	1/4	5/8
D4R12	1/4	3/4
D5R6	5/16	3/8
D5R8	5/16	1/2
D6R4	3/8	1/4
D6R6	3/8	3/8
D6R8	3/8	1/2
D6R10	3/8	5/8
D6R12	3/8	3/4
D8R4	1/2	1/4
D8R6	1/2	3/8
D8R8	1/2	1/2
D8R10	1/2	5/8
D8R12	1/2	3/4
D8R16	1/2	1
D10R12	5/8	3/4
D10R14	5/8	7/8
D10R16	5/8	1
D12R8	3/4	1/2
D12R16	3/4	1
D20R24	1-1/4	1-1/2

NOTE: For Heat Exchanger Tee applications, certain Reducer / Adapter fittings can be “bored through” to accommodate a process tube’s insertion. Consult with the local distributor for further information on “bored through” Reducer / Adapter (RBT) fittings.

Tube Stub Connectors / Adapters

R

Reducer / Adapter
For Metric Tube



Duolok Part #	Tube 1 O.D. (mm)	Tube 2 O.D. (mm)
DM3RM4	3	4
DM3RM6	3	6
DM3RM10	3	10
DM4RM6	4	6
DM6RM3	6	3
DM6RM8	6	8
DM6RM10	6	10
DM6RM12	6	12
DM6RM18	6	18
DM8RM6	8	6
DM8RM10	8	10
DM8RM12	8	12
DM10RM6	10	6
DM10RM8	10	8
DM10RM12	10	12
DM10RM15	10	15
DM10RM18	10	18
DM12RM6	12	6
DM12RM8	12	8
DM12RM10	12	10
DM12RM16	12	16
DM12RM18	12	18
DM12RM20	12	20
DM12RM22	12	22
DM12RM25	12	25
DM16RM12	16	12
DM18RM12	18	12
DM18RM16	18	16
DM18RM20	18	20
DM18RM22	18	22
DM18RM25	18	25
DM20RM16	20	16
DM20RM18	20	18
DM20RM22	20	22
DM20RM25	20	25
DM22RM18	22	18
DM22RM20	22	20
DM22RM25	22	25
DM25RM18	25	18
DM25RM20	25	20

Tube Stub Connectors / Adapters

MA

Male Adapter

- NPT

For Fractional Tube



Duolok Part #	Tube O.D. (in.)	NPT Male Pipe (in.)
D2MA2	1/8	1/8
D2MA4	1/8	1/4
D3MA2	3/16	1/8
D3MA4	3/16	1/4
D4MA2	1/4	1/8
D4MA4	1/4	1/4
D4MA6	1/4	3/8
D4MA8	1/4	1/2
D5MA2	5/16	1/8
D5MA4	5/16	1/4
D6MA2	3/8	1/8
D6MA4	3/8	1/4
D6MA6	3/8	3/8
D6MA8	3/8	1/2
D8MA4	1/2	1/4
D8MA6	1/2	3/8
D8MA8	1/2	1/2
D10MA8	5/8	1/2
D12MA8	3/4	1/2
D12MA12	3/4	3/4
D16MA12	1	3/4
D16MA16	1	1

MA

Male Adapter

- NPT

For Metric Tube

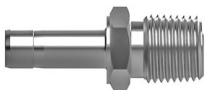

Duolok Part #	Tube O.D. (mm)	NPT Male Pipe (in.)
DM6MA2	6	1/8
DM6MA4	6	1/4
DM8MA4	8	1/4
DM10MA4	10	1/4
DM10MA6	10	3/8
DM10MA8	10	1/2
DM12MA4	12	1/4
DM12MA8	12	1/2

Tube Stub Connectors / Adapters

FA

Female Adapter - FNPT

For Fractional Tube

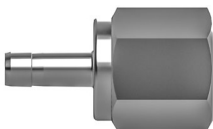

Duolok Part #	Tube O.D. (in.)	NPT Female Pipe (in.)
D2FA2	1/8	1/8
D2FA4	1/8	1/4
D3FA4	3/16	1/4
D4FA2	1/4	1/8
D4FA4	1/4	1/4
D4FA6	1/4	3/8
D4FA8	1/4	1/2
D5FA4	5/16	1/4
D6FA2	3/8	1/8
D6FA4	3/8	1/4
D6FA6	3/8	3/8
D6FA8	3/8	1/2
D8FA4	1/2	1/4
D8FA6	1/2	3/8
D8FA8	1/2	1/2
D10FA8	5/8	1/2
D12FA8	3/4	1/2
D12FA12	3/4	3/4
D12FA16	3/4	1
D16FA12	1	3/4
D16FA16	1	1

FA

Female Adapter - FNPT

For Metric Tube

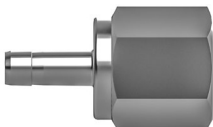

Duolok Part #	Tube O.D. (mm)	NPT Female Pipe (in.)
DM6FA2	6	1/8
DM6FA4	6	1/4
DM8FA4	8	1/4
DM10FA4	10	1/4
DM10FA6	10	3/8
DM10FA8	10	1/2
DM12FA4	12	1/4
DM12FA8	12	1/2

Tube Stub Connectors / Adapters

PC

Port Connector
For Fractional Tube



Duolok Part #	Tube O.D. (in.)
D1PC	1/16
D2PC	1/8
D4PC	1/4
D5PC	5/16
D6PC	3/8
D8PC	1/2
D12PC	3/4
D16PC	1

PC

Port Connector
For Metric Tube



Duolok Part #	Tube O.D. (mm)
DM3PC	3
DM6PC	6
DM8PC	8
DM10PC	10
DM12PC	12
DM15PC	15
DM16PC	16
DM18PC	18
DM20PC	20
DM25PC	25

RPC

Reducing
Port Connector
For Fractional Tube



Duolok Part #	Tube 1 O.D. (in.)	Tube 2 O.D. (in.)
D2RPC1	1/8	1/16
D4RPC1	1/4	1/16
D4RPC2	1/4	1/8
D6RPC2	3/8	1/8
D6RPC4	3/8	1/4
D8RPC4	1/2	1/4
D8RPC6	1/2	3/8
D12RPC8	3/4	1/2

RPC

Reducing
Port Connector
For Metric Tube



Duolok Part #	Tube 1 O.D. (mm)	Tube 2 O.D. (mm)
DM6RPCM3	6	3
DM8RPCM6	8	6
DM10RPCM6	10	6
DM10RPCM8	10	8
DM12RPCM6	12	6
DM12RPCM8	12	8
DM12RPCM10	12	10
DM16RPCM12	16	12

Tube Stub Connectors / Adapters

HBA

Hose Barb Adapter

For Fractional Tube



Duolok Part #	Hose I.D. (in.)	Tube Size (in.)
D2HBA2	1/8	1/8
D2HBA4	1/8	1/4
D4HBA4	1/4	1/4
D4HBA6	1/4	3/8
D5HBA4	5/16	1/4
D6HBA6	3/8	3/8
D6HBA8	3/8	1/2
D8HBA6	1/2	3/8
D8HBA8	1/2	1/2
D12HBA12	3/4	3/4

CU1

Calibration Union

For Fractional Tube

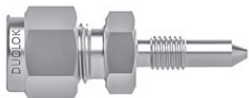

Duolok Part #	Tube O.D. (in.)
D4CU1	1/4

CU2

Calibration Union

For Fractional Tube

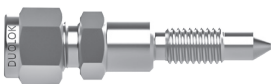

Duolok Part #	Tube O.D. (in.)
D4CU2	1/4

Duolok to 37° Flare

ANU

AN Union

For Fractional Tube



Duolok Part #	Tube O.D. (in.)	AN Tube Flare Size (in.)
D1ANU2	1/16	1/8
D2ANU2	1/8	1/8
D2ANU4	1/8	1/4
D4ANU4	1/4	1/4
D5ANU5	5/16	5/16
D6ANU4	3/8	1/4
D6ANU6	3/8	3/8
D8ANU8	1/2	1/2
D12ANU12	3/4	3/4
D16ANU16	1	1

ANBU

AN Bulkhead Union

For Fractional Tube



Duolok Part #	Tube O.D. (in.)	AN Tube Flare Size (in.)
D4ANBU4	1/4	1/4
D6ANBU6	3/8	3/8
D8ANBU8	1/2	1/2
D12ANBU12	3/4	3/4
D16ANBU16	1	1

ANF

Female AN Adapter

For Fractional Tube



Duolok Part #	Tube O.D. (in.)	AN Flare Size (in.)
D2ANF2	1/8	1/8
D2ANF4	1/8	1/4
D4ANF4	1/4	1/4
D6ANF6	3/8	3/8
D8ANF8	1/2	1/2

Duolok to 37° Flare

ANA

*AN Adapter
For Fractional Tube*

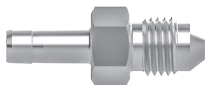

Duolok Part #	Tube O.D. (in.)	AN Tube Flare Size (in.)
D4ANA4	1/4	1/4
D6ANA4	3/8	1/4
D6ANA6	3/8	3/8
D8ANA8	1/2	1/2
D12ANA12	3/4	3/4
D16ANA16	1	1

Tube to O-Ring Seal

OMC

*O-Ring
Seal Male
Connector*
For Fractional Tube*

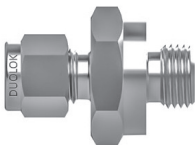

Duolok Part #	Tube O.D. (in.)	NPT* Male Pipe (in.)
D2OMC2	1/8	1/8
D4OMC2	1/4	1/8
D4OMC4	1/4	1/4
D6OMC4	3/8	1/4
D6OMC6	3/8	3/8
D6OMC8	3/8	1/2
D8OMC8	1/2	1/2

*Connects to Female Short NPT Thread

OSC

*O-Ring Seal Male
Straight Thread
Connector*
For Fractional Tube*

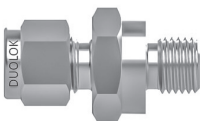

Duolok Part #	Tube O.D. (in.)	Thread Size
D1OSC2	1/16	5/16 - 24
D2OSC2	1/8	5/16 - 24
D3OSC3	3/16	3/8 - 24
D4OSC4	1/4	7/16 - 20
D5OSC5	5/16	1/2 - 20
D6OSC6	3/8	9/16 - 18
D8OSC8	1/2	3/4 - 16
D12OSC12	3/4	1-1/16 - 12
D16OSC16	1	1-5/16 - 12

*Connects to Female Straight Thread - SAE J1926

Tube to SAE / MS

MCST

Male Connector -
Straight Thread

Boss

For Fractional Tube

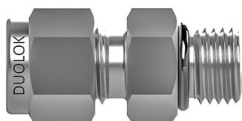

Duolok Part #	Tube O.D. (in.)	Thread Size
D2MCST2	1/8	5/16 - 24
D4MCST4	1/4	7/16 - 20
D4MCST6	1/4	9/16 - 18
D4MCST8	1/4	3/4 - 16
D4MCST10	1/4	7/8 - 14
D5MCST5	5/16	1/2 - 20
D6MCST4	3/8	7/16 - 20
D6MCST6	3/8	9/16 - 18
D6MCST8	3/8	3/4 - 16
D6MCST10	3/8	7/8 - 14
D8MCST6	1/2	9/16 - 18
D8MCST8	1/2	3/4 - 16
D8MCST10	1/2	7/8 - 14
D8MCST12	1/2	1-1/16 - 12
D10MCST8	5/8	3/4 - 16
D10MCST10	5/8	7/8 - 14
D12MCST8	3/4	3/4 - 16
D12MCST12	3/4	1-1/16 - 12
D14MCST14	7/8	1-3/16 - 12
D16MCST12	1	1-1/16 - 12
D16MCST16	1	1-5/16 - 12
D20MCST20	1-1/4	1-5/8 - 12
D24MCST24	1-1/2	1-7/8 - 12

90 Durometer Viton® O-Ring is standard. Other O-Ring compounds are available.

MEST

Male Elbow -
Straight Thread

Boss

For Fractional Tube



Duolok Part #	Tube O.D. (in.)	SAE / MS Thread Size
D4MEST4	1/4	7/16 - 20
D4MEST6	1/4	9/16 - 18
D5MEST5	5/16	1/2 - 20
D6MEST4	3/8	7/16 - 20
D6MEST6	3/8	9/16 - 18
D6MEST8	3/8	3/4 - 16
D8MEST6	1/2	9/16 - 18
D8MEST8	1/2	3/4 - 16
D10MEST10	5/8	7/8 - 14
D12MEST12	3/4	1-1/16 - 12
D16MEST16	1	1-5/16 - 12
D20MEST20	1-1/4	1-5/8 - 12

90 Durometer Viton® O-Ring is standard. Other O-Ring compounds are available.

Tube to SAE / MS

M45EST

*45° Male Elbow -
Straight Thread
Boss*

For Fractional Tube

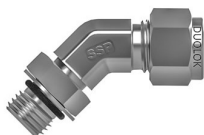

Duolok Part #	Tube O.D. (in.)	SAE / MS Thread Size
D4M45EST4	1/4	7/16 - 20
D6M45EST6	3/8	9/16 - 18
D8M45EST8	1/2	3/4 - 16
D12M45EST12	3/4	1-1/16 - 12
D16M45EST16	1	1-5/16 - 12

90 Durometer Viton® O-Ring is standard. Other O-Ring compounds are available.

MBTST

*Male Branch
Tee - Straight
Thread Boss*

For Fractional Tube



Duolok Part #	Tube O.D. (in.)	SAE / MS Thread Size
D4MBTST4	1/4	7/16 - 20
D6MBTST6	3/8	9/16 - 18
D8MBTST8	1/2	3/4 - 16
D12MBTST12	3/4	1-1/16 - 12
D16MBTST16	1	1-5/16 - 12

90 Durometer Viton® O-Ring is standard. Other O-Ring compounds are available.

Tube to SAE / MS

MRTST

*Male Run
Tee - Straight
Thread Boss
For Fractional Tube*



Duolok Part #	Tube O.D. (in.)	SAE / MS Thread Size
D4MRTST4	1/4	7/16 - 20
D6MRTST6	3/8	9/16 - 18
D8MRTST8	1/2	3/4 - 16
D12MRTST12	3/4	1-1/16 - 12
D16MRTST16	1	1-5/16 - 12

90 Durometer Viton® O-Ring is standard. Other O-Ring compounds are available.

MAST

*Male Adapter -
Straight Thread
Boss
For Fractional Tube*

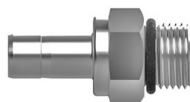

Duolok Part #	Tube O.D. (in.)	SAE / MS Thread Size
D2MAST2	1/8	5/16 - 24
D4MAST4	1/4	7/16 - 20
D6MAST4	3/8	7/16 - 20
D6MAST6	3/8	9/16 - 18
D6MAST8	3/8	3/4 - 16
D8MAST6	1/2	9/16 - 18
D8MAST8	1/2	3/4 - 16
D12MAST12	3/4	1-1/16 - 12
D16MAST16	1	1-5/16 - 12

90 Durometer Viton® O-Ring is standard. Other O-Ring compounds are available.

Cap and Plug

CP

Cap

For Fractional Tube



Duolok Part #	Tube O.D. (in.)
D1CP	1/16
D2CP	1/8
D3CP	3/16
D4CP	1/4
D5CP	5/16
D6CP	3/8
D8CP	1/2
D10CP	5/8
D12CP	3/4
D14CP	7/8
D16CP	1
D20CP	1-1/4
D24CP	1-1/2

CP

Cap

For Metric Tube



Duolok Part #	Tube O.D. (mm)
DM3CP	3
DM4CP	4
DM6CP	6
DM8CP	8
DM10CP	10
DM12CP	12
DM14CP	14
DM15CP	15
DM16CP	16
DM18CP	18
DM20CP	20
DM22CP	22
DM25CP	25

Cap and Plug

P

Plug

For *Fractional* Tube



Duolok Part #	Tube O.D. (in.)
D1P	1/16
D2P	1/8
D3P	3/16
D4P	1/4
D5P	5/16
D6P	3/8
D8P	1/2
D10P	5/8
D12P	3/4
D16P	1
D20P	1-1/4
D24P	1-1/2

P

Plug

For *Metric* Tube



Duolok Part #	Tube O.D. (mm)
DM3P	3
DM4P	4
DM6P	6
DM8P	8
DM10P	10
DM12P	12
DM15P	15
DM16P	16
DM18P	18
DM20P	20
DM22P	22
DM25P	25

N

Nut

For Fractional Tube



Duolok Part #	Tube O.D. (in.)
D1N	1/16
D2N	1/8
D3N	3/16
D4N	1/4
D5N	5/16
D6N	3/8
D8N	1/2
D10N	5/8
D12N	3/4
D14N	7/8
D16N	1
D20N	1-1/4
D24N	1-1/2
D32N	2

N

Nut

For Metric Tube



Duolok Part #	Tube O.D. (mm)
DM3N	3
DM4N	4
DM6N	6
DM8N	8
DM10N	10
DM12N	12
DM14N	14
DM15N	15
DM16N	16
DM18N	18
DM20N	20
DM22N	22
DM25N	25

Components

BF

Back Ferrule

For Fractional Tube



Duolok Part #	Tube O.D. (in.)
D1BF	1/16
D2BF	1/8
D3BF	3/16
D4BF	1/4
D5BF	5/16
D6BF	3/8
D8BF	1/2
D10BF	5/8
D12BF	3/4
D14BF	7/8
D16BF	1
D20BF	1-1/4
D24BF	1-1/2
D32BF	2

BF

Back Ferrule

For Metric Tube



Duolok Part #	Tube O.D. (mm)
DM3BF	3
DM4BF	4
DM6BF	6
DM8BF	8
DM10BF	10
DM12BF	12
DM14BF	14
DM15BF	15
DM16BF	16
DM18BF	18
DM20BF	20
DM22BF	22
DM25BF	25

Components

FF

Front Ferrule
For Fractional Tube



Duolok Part #	Tube O.D. (in.)
D1FF	1/16
D2FF	1/8
D3FF	3/16
D4FF	1/4
D5FF	5/16
D6FF	3/8
D8FF	1/2
D10FF	5/8
D12FF	3/4
D14FF	7/8
D16FF	1
D20FF	1-1/4
D24FF	1-1/2
D32FF	2

FF

Front Ferrule
For Metric Tube



Duolok Part #	Tube O.D. (mm)
DM3FF	3
DM4FF	4
DM6FF	6
DM8FF	8
DM10FF	10
DM12FF	12
DM14FF	14
DM15FF	15
DM16FF	16
DM18FF	18
DM20FF	20
DM22FF	22
DM25FF	25

FS

Ferrule Set
For Fractional Tube



Duolok Part #	Tube O.D. (in.)
D1FS	1/16
D2FS	1/8
D3FS	3/16
D4FS	1/4
D5FS	5/16
D6FS	3/8
D8FS	1/2

FS

Ferrule Set
For Metric Tube



Duolok Part #	Tube O.D. (mm)
DM6FS	6
DM8FS	8
DM10FS	10
DM12FS	12

A Ferrule Set consists of one front ferrule and one back ferrule and is conveniently packaged and sold in multiples of ten sets per "holding tube" housing.

Components

KN

Knurled Nut

For Fractional Tube



Duolok Part #	Tube O.D. (in.)
D1KN	1/16
D2KN	1/8
D3KN	3/16
D4KN	1/4
D5KN	5/16
D6KN	3/8
D8KN	1/2
D10KN	5/8
D12KN	3/4
D14KN	7/8
D16KN	1

BN

Bulkhead Locknut

For Fractional Tube



Duolok Part #	Tube O.D. (in.)
D1BN	1/16
D2BN	1/8
D3BN	3/16
D4BN	1/4
D5BN	5/16
D6BN	3/8
D8BN	1/2
D10BN	5/8
D12BN	3/4
D14BN	7/8
D16BN	1

RG

RG Fitting Gasket

For Metric Tube



Duolok Part #	O.D. (mm)	I.D. (mm)
4RG-CU	10.7	7.6
6RG-CU	14.2	8.6
8RG-CU	17.8	9.1

Components

TI

Tube Insert

For Fractional Tube

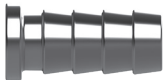

Duolok Part #	Tube O.D. (in.)	Tube I.D. (in.)
D3TI2	3/16	1/8
D4TI2	1/4	1/8
D4TI170	1/4	0.170
D4TI3	1/4	3/16
D5TI2	5/16	1/8
D5TI3	5/16	3/16
D5TI4	5/16	1/4
D6TI3	3/8	3/16
D6TI4	3/8	1/4
D8TI4	1/2	1/4
D8TI6	1/2	3/8
D10TI6	5/8	3/8
D10TI8	5/8	1/2
D12TI8	3/4	1/2
D12TI10	3/4	5/8
D16TI12	1	3/4

TI

Tube Insert

For Metric Tube

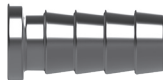

Duolok Part #	Tube O.D. (mm)	Tube I.D. (mm)
DM6TI4	6	4
DM8TI6	8	6
DM10TI8	10	8
DM12TI8	12	8
DM12TI10	12	10

DW

Bonded Washer

For Fractional Tube



Duolok Part #	ISO Pipe Size (in.)
2DW-BSPP-SS-V	1/8
4DW-BSPP-SS-V	1/4
6DW-BSPP-SS-V	3/8
8DW-BSPP-SS-V	1/2
12DW-BSPP-SS-V	3/4
16DW-BSPP-SS-V	1

Comes standard as a 300 series stainless steel outer ring with a Viton® inner ring bonded to it. Also available with Buna-N. Replace -V with -B if Buna-N is Required.

SSP Tubing

SSP Tubing

For Fractional Tube

SSP Part Number	Tube O.D. (in.)	Wall Thickness
RTT3160125X028	1/8	0.028
RTT3160250X035	1/4	0.035
RTT3160250X049		0.049
RTT3160250X065		0.065
RTT3160375X035		0.035
RTT3160375X049	3/8	0.049
RTT3160375X065		0.065
RTT3160500X035		0.035
RTT3160500X049	1/2	0.049
RTT3160500X065		0.065
RTT3160625X065		0.065
RTT3160750X065	3/4	0.065
RTT3160750X095		0.095
RTT3161000X083		1
RTT3161000X109	0.109	

SSP Tubing

For Metric Tube

SSP Part Number	Tube O.D. (mm)	Wall Thickness
RTT316M06XM1.0	6	1.0
RTT316M06XM1.5		1.5
RTT316M08XM1.0	8	1.0
RTT316M08XM1.5		1.5
RTT316M10XM1.0	10	1.0
RTT316M10XM1.5		1.5
RTT316M12XM1.0	12	1.0
RTT316M12XM1.5		1.5
RTT316M12XM2.0		2.0
RTT316M16XM1.5	16	1.5
RTT316M16XM2.0		2.0
RTT316M18XM1.5	18	1.5
RTT316M18XM2.0		2.0
RTT316M20XM2.0	20	2.0
RTT316M25XM1.5	25	1.5
RTT316M26XM2.0		2.0

Safety

To help ensure the safe and reliable performance of tube fitting products, complete system design must be considered prior to the installation of the tubing and tube fittings. Determining the design compatibility of materials, media, flows, temperatures and pressures; as well as implementing proper installation, operation and maintenance of the system are the responsibility of the systems' owners, designers and users.

SSP Safety Reminders

All SSP products are designed and manufactured with safety in mind. The following is a limited list of general safety practices:

Do not install, tighten or loosen a tube fitting while the system is under pressure.

Do not loosen a tube fitting, nut or plug to relieve or bleed system pressure.

Always use a back-up wrench to hold the tube fitting body steady when tightening or loosening tube fitting nuts.

There is no need to disassemble a new tube fitting prior to use.

Use proper thread lubricants and sealants on tapered pipe threads.

Very soft, pliable plastic tubing requires a tube insert.

Tube fitting and tubing material should be similar (stainless steel fittings on stainless steel tubing, brass fittings on copper tubing, etc.) with the tubing material being fully annealed. For more specific information, refer to the Selection Guide for Instrumentation Tubing in the Duolok® catalog.

Do not weld tube fittings that are assembled. Prior to welding, remove the nut and ferrules and protect the seat and thread area of the tube fitting by covering with a plug or another nut.

Duolok® Tube Fittings LIFETIME LIMITED WARRANTY

SSP guarantees all Duolok tube fittings and Duolok tube fitting components to be free from defects in materials and workmanship. Additionally, SSP guarantees Duolok product performance to the published catalog specifications when properly installed according to the catalog selection and installation instructions. To initiate a warranty claim, suspected defective product must be returned to SSP with the nature of potential defect documented for factory evaluation. Any product with a determined defect in material or workmanship will be replaced with an equivalent product at no charge.

This warranty comprises the sole and entire warranty pertaining to items provided hereunder. There is no other warranty, guarantee, express or implied representation of any kind whatsoever. All other warranties including, but not limited to, merchantability and fitness for purpose, whether express, implied, or arising by operation of law. Course of dealing, or trade usage are hereby disclaimed. There are no warranties which extend beyond the description on the face hereof; and this warranty does not apply in the case of abuse, mishandling, or normal use depreciation. In no event, whether alleged to arise from breach of contract, express or implied warranty, by operation of law, negligence or otherwise, will SSP be liable for any incidental, consequential, lost property, or other special damages of any kind whatsoever. The exclusive only remedy under this warranty is the replacement of determined defective parts as set forth above.

Duolok[®], Unilok[®], Griplok[®], TruFit[®] & FloLok[®] are registered trademarks of SSP Fittings Corp.

Swagelok[®] and Cajon[®] are registered trademarks of Swagelok Co. Parker CPI[®] and ParkerTM are registered trademarks of Parker Hannifin.

Hoke Gyrolok[®] and Hoke[®] are registered trademarks of Hoke Inc. Viton[®] and Teflon[®] are registered trademarks of E.I. duPont Nemours and Co.

Monel[®] is a registered trademark of Inco Alloys International

NOTICE: This publication is an uncontrolled copy of a controlled document. SSP has made every reasonable effort to insure the accuracy of the information contained in this publication, and is not to be held liable in any manner for any mistakes, omissions, typographical and/or printing errors.



WARNING

IMPROPER SELECTION OR IMPROPER USE OF THE PRODUCTS DESCRIBED HEREIN OR RELATED ITEMS CAN CAUSE PERSONAL INJURY AND PROPERTY DAMAGE.

It is the sole responsibility of the system designers and users to properly select and use products for their specific applications. This document has been printed for users with technical expertise as a reference for further investigation to determine specific product needs relative to design requirements.

SSP

Founded 1926

Privately owned, third generation business

Modern single-site vertically integrated manufacturing facility

DFARS-compliant raw material

ISO 9001 quality management system

Limited Lifetime Warranty



*The Only
100% American Made
Instrument Valves & Fittings*

8250 Boyle Parkway • Twinsburg, OH 44087

330-425-4250 • www.mySSP.com

©2020 SSP Fittings Corp. All rights reserved.

SSPDIPG-20A